

RTU32S

RTU32S Series – Small Compact Utility RTU

Data Sheet

40270 v1.07 / Dec. 2016



**Now includes LCD for I/O
and RTU Status Display!**

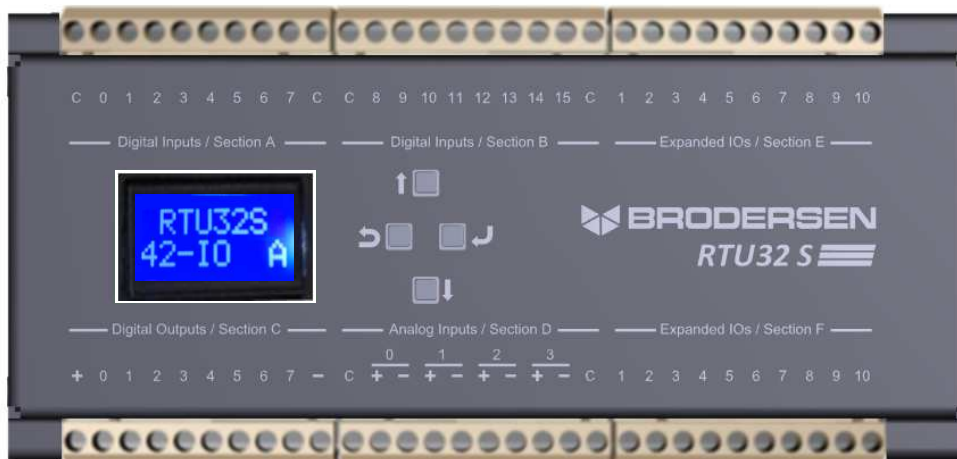

INTRODUCTION

Brodersen Small Compact RTU32S Series with advanced RTU/PLC functionality.

The RTU32S series is based on an embedded 32-bit industrial platform providing flexible RTU functionality for smaller remote monitoring and control applications in the utility and infrastructure markets.

Physical communication interfaces includes LAN 10/100MBit/s, COM ports and USB ports. The RTU32S offers support for optional internal or external communication devices like data radios, GSM/GPRS/3G, Wi-Fi, dial-modems etc. Making it the perfect future proof solution for new application designs and for mounting in areas where there are no hardwired communication facilities.

The RTU32S supports a variety of standard and open protocols such as Modbus, IEC60870 and DNP3. It also includes the fast event based Binding protocol - a fast and reliable way to distribute time stamped event data between any Brodersen RTU32s in the network.

The RTU32S has a web-based configuration interface for setup of the RTU 'personality' eg. IP address, IO range, Slave address etc. Additional RTU functionality, including logic, messaging and logging are configured in the Brodersen WorkSuite.

A robust aluminum enclosure suitable for DIN rail mounting the RTU32S module is 80mmH, 178mmW and 80mmD.

The RTU32S series is available in three power supply configurations. These include 10-30VDC, 20-60VDC and 90-265 VAC/DC. An external UPS option is available using Brodersen UPS power supply module UCS-CHRxxx.

The RTU32S is available with a range of integrated I/O options – 28IO and 16DIO. In addition it supports I/O expansion via the Brodersen I/O LocalBus.

FEATURE LIST

- Small Compact RTU with or without integrated I/O and communication device.
- Reliable Real Time Operating System.
- Communication Protocols Supported:
 - Full Modbus suite.
 - IEC60870-5-101/103/104 Protocol.
 - DNP3 Slave.
 - Binding - Global Distribution and Subscription of Event Based Time Stamped Variables.
- Communication Protocols can also be created as part of the logic application interface. A number of legacy and device specific protocols have been created that include:
 - Omron Host Link
 - 4RF SNMP Client
 - Radtel RDCMP
- Communication interfaces; 1 x Ethernet and 3 x RS232 COM.
- Integrated I/Os and I/O Expansion via Brodersen LocalBus
- Full EN/IEC61131 PLC runtime – also used for special and flexible data manipulation.
- Includes power supply monitoring of the RTU32S supply voltage and temperature
- A wide range of power supply input voltage options
- Full remote management with configuration, programming and flexible distribution of all levels of software from and to RTUs on remote locations.



VERSIONS / ORDERING CODES

Order code example	BRS-42IO /1A005.91	
Type	BRS	
RTU32S		
I/O integration versions		
Basic - without I/O	A	
16DI/8DO/4AI	28IO	
16DI/16DO	16DIO	
20DI/8DO/8DIO/6AI	42IO	
Memory options		
128MB SD Flash	1	
Special options		
Standard configuration	A	
Integrated COM (later options)		
No internal modem	0	
PSTN Dial modem	1*	
GSM	2*	
GPRS/3G	3*	
Power supply option		
10-30VDC	05	
90-265VAC/DC	10	
20-60VDC	30	
I/O options		
No IO on RTU	00	
Analog input range:		
No analog input	0x	
0-10VDC	1x	
4-20mA	2x	
0-20mA	6x	
Configurable (voltage)	8x**	
Configurable (current)	9x**	
Digital input range:		
No digital input	x0	
12-24VDC unipolar	x1	

- * Future option
 - ** The only difference between 8x and 9x is the predefined setting of their current/voltage selection jumpers (for all AI channels):
 - 8x : Configurable in different ranges of voltage input
 - 9x : Configurable in different ranges of current input
- Each AI channel (in both 8x and 9x) can also be changed to the other type by changing the state of their internal current/voltage selection jumpers.

TECHNICAL DESCRIPTION

Software – General

RTU32S open Real Time Operating System is based around Windows CE Embedded 6. It offers access and support to a wide range of standard network protocols - TCP/IP, UDP, HTML, FTP, SNTP and SMTP. Windows CE Embedded allows priorities for fast PLC runtime execution and parallel multiple communications task handling.

Software – Basic Setup and Configuration

Basic configuration of the RTU32S is via an Internet Browser connected to the integrated WebServer. Configuration includes settings for IP network communications, I/O configuration and SNTP (time synchronization via Simple Network Management Protocol) etc.

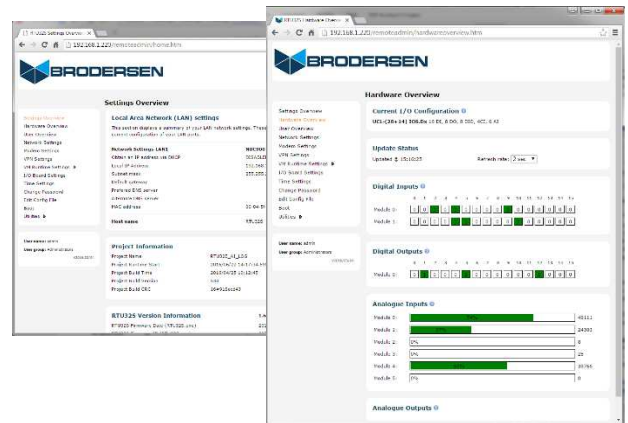

The configuration also defines settings for the Brodersen 3G/GPRS modem when connected to the RTU's USB interface - including APN and user authentication setup. Full remote configuration and complete RTU software update are possible via all communication interfaces.

Software – RTU Logic Configuration and Programming

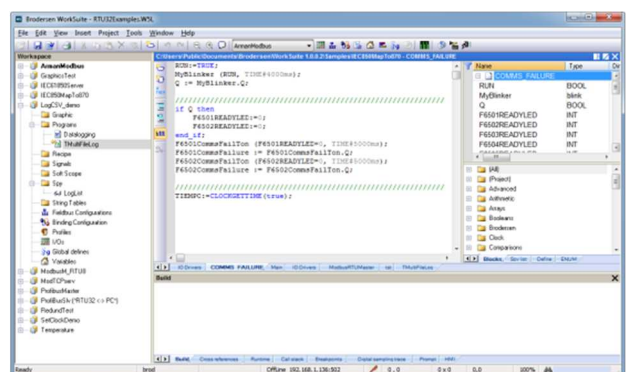



The RTU's logic 'engine' is setup and programmed using the Brodersen WorkSuite. This IEC61131 application development environment supports all 5 languages: ST, FB, SFC, LD and IL.

WorkSuite allows creation and management of applications that provide the RTU with PLC runtime functionality. WorkSuite is a very flexible and powerful tool to use in your application development. It includes features such as:

- Fieldbus and profile editor for simple and fast driver setup.
- Definition of variables from simple Booleans to advanced Arrays and Structures.
- Freeform program language mix, full conversion features and program prioritizing.
- Full Simulation and debugging functions.
- Large library of ready to use functions.
- Create your own User Defined Function Blocks in a PLC language or C.

Full remote programming is possible via all RTU communication interfaces.

Brodersen also provide tools and wizards to simplify and decrease the total time of application development. These tools include a complete IEC60870 Driver Configuration Tool (IEC60870CONFIG) enabling setup of an IEC60870 driver in an Excel sheet in less than 30 minutes.

Software – Communication Drivers/Protocols

RTU32S support a range of standard drivers/protocols;

- IEC60870-5-101 Slave including dial functions.
- IEC60870-5-103 Master.
- IEC60870-5-104 Server.
- I/O drivers for integrated I/O and LocalBus I/O Expansion.
- Modbus-RTU Master and Slave.
- Modbus-TCP Client and Server.
- Modbus-ASCII Drivers.
- DNP3 Server/Slave
- Distributed event based Binding protocol for fast RTU to RTU communication.

Future Drivers for RTU32S:

- SNMP Agent
- DF1 Master
- DNP3 WITS Slave
- DNP3 Master

Software – I/O Drivers

The RTU32S supports dedicated I/O LocalBus drivers for Brodersen integrated and Expansion I/O modules.

I/O Drivers includes direct I/O board definitions and variable profile assignment definitions.

Modem Control / Dial-up / Dial-in

Dial-up and dial-in functions are supported by the RTU32S. These are used for PSTN or GSM modems connected to the serial port/s of the RTU32S. They can be used for any serial communication e.g. Modbus-RTU, DNP3 and IEC60870 serial protocols.

Real-Time / Real-Time Clock

The WinCE real-time task is used for the application program execution. Time stamps and cyclic execution are also based on the WinCE real-time clock. Time stamps are reported in milliseconds resolution. The RTU32S support clock synchronization via SNTP and utility protocols.

COM communication for Null-Modem, Radio and Leased Line modems

The RTU32S has implemented extended necessary data communication features for communication of Modbus-RTU, DNP3 and IEC60870-5-101 over serial modems and converters. The features cover detailed handshake control with timing of RTS and CTS.

3G / GPRS Modem controlled directly by RTU32S

The RTU32S supports external UCM-94 3G/GPRS modem connected directly via USB Interface. Software is available to handle automatic connection to a defined APN. Additional logic functions allow control and monitoring of the modem connection.

Power supply options

The RTU32S offers the following power supply input options; 10-30VDC, 20-60VDC and 90-265VAC/DC. If battery backed UPS functionality is required, Brodersen recommend the UCS-CHRxxx UPS power supplies. All power supply options provide IO Expansion bus power for up to 600mA@12VDC.

Other interfaces

The RTU32S has two USB ports for interfacing with the Brodersen 3G Modem, Ethernet converters, external memory etc.



I/O CONFIGURATIONS

The RTU32S supports a wide range of integrated IO configurations as well as the range of Brodersen external IO Expansion modules via the LocalBus RJ45 connector.

The RTU32S can also be used with 3rd party distributed I/O via any of the supported drivers – e.g. Modbus-TCP.

Integrated I/O options

The RTU32S is available in standard I/O configurations including 28IO, 42IO and 16DIO (16DI+16DO). The RTU32S can be expanded to support a larger number of I/O and supports up to 12x I/O expansion modules.

I/O Expansion

The RTU32S can be used with all existing UCL type Brodersen I/O Expansion modules. No programming or configuration is required – the RTU32S supports automatic I/O configuration of Brodersen I/O Expansion modules.



The LocalBus interface includes both the reliable and well proven IO communication bus and power supply for I/O Expansion modules.

OPTIONAL I/O CONFIGURATIONS (Future)

The RTU32S Series offers flexible I/O combinations for higher quantity orders.

INTERFACE OVERVIEW

Top view

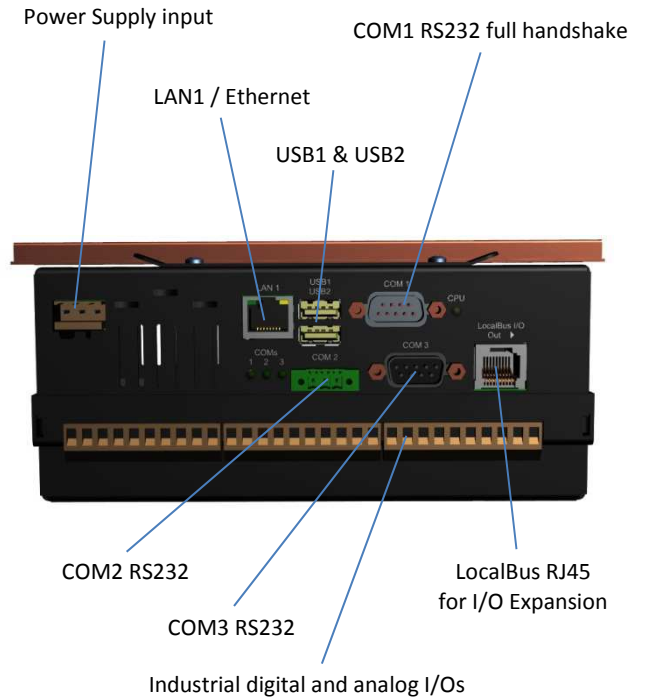

Bottom view

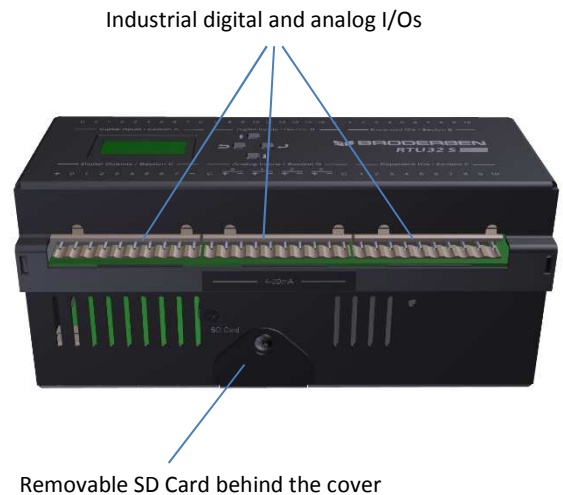

**TECHNICAL SPECIFICATIONS****HARDWARE - BASICS**

CPU:	Nuvoton 32-bit W90P910 ARM9 200 MHz
Memory:	RAM: 64MB SDRAM NAND Flash: 128MB SD Card Flash disc – removable
RTC:	Integrated and battery backed RealTimeClock with 1 msec resolution RTC accuracy: 34 ppm.
Interfaces:	LAN: 10/100Mbps RJ45, not isolated COM1 RS232, full HW handshake and up to 115.200baud, D-sub male 9 pin, not isolated. COM2 RS232, via 3 pin screw connector with Rx, Tx and Gnd. Up to 115.200baud, not isolated. COM3 RS232, up to 115.200baud – D-sub male 9 pin, not isolated. 2 x USB 2.0. I/O LocalBus for support up to 12 I/O Modules – RJ45.

RTU32S PLC RUNTIME**PLC Runtime performance:**

Minimum cycle time:	40msec
Typical cycle time:	100msec
Scan time internal I/O:	Min. 25msec
Scan time external I/O:	Min. 50msec
Maximum PLC variables:	2 x 20kb – calculated as sum of all variables.

INTEGRATED INDUSTRIAL I/O VERSIONS**28IO**

16 x opto-isolated digital inputs, 10-30VDC
8 x opto-isolated HSS digital outputs, 10-30VDC
4 x isolated analog Inputs, multi-range, voltage/current (eg.0-5V, 1-5V, 0-10V, 0-20mA, 4-20mA)

42IO

16 x isolated digital inputs, 10-30VDC
8 x isolated HSS digital outputs, 10-30VDC

6 x isolated analog Inputs, multi-range, voltage/current (eg.0-5V, 1-5V, 0-10V, 0-20mA, 4-20mA)
4 x isolated digital/counter inputs, 5-30VDC, up to 2 KHz
8 x isolated configurable digital I/Os, 10-30VDC.

16DIO

16 x isolated digital inputs, 10-30VDC
16 x isolated PNP digital outputs, 10-30VDC

LocalBus I/O interface for I/O Expansion

Supports all Brodersen UCL I/O Expansion modules.

INTEGRATED DIGITAL INPUT/OUTPUT**Digital inputs:**

Input voltage activated:	10-30VDC
Input voltage deactivated:	Min. 3VDC
Input current (typical):	12V DC: 3mA 24V DC: 6mA
Input delay (typical):	1ms
Isolation:	2KV AC (opto-isolated)

Note: Default standard digital inputs are unipolar 10-30VDC. Digital inputs can optionally be delivered in ranges such as 24-48VDC, 40-70VDC – in unipolar or bipolar configuration.

Fast digital / 32-bit Counter Inputs (on 42IO version)

Input voltage activated:	5-30VDC
Input voltage deactivated:	Min. 3VDC
Input frequency:	up to 5 KHz
Input current (typical):	12V DC: 4mA 24V DC: 8.4mA
Isolation:	2KV AC (Opto-isolated)

Digital outputs:

External voltage:	10 - 30V DC
Output switch type:	Smart high side switch (28IO and 42IO versions) or PNP transistor (16DIO version)
Current per output:	0.5A (max)
Output delay:	1ms (max.)
On resistance:	160mΩ (typ.)
Output leakage current:	7µA (max. in off state)
Output peak current:	1.5A (typ.)
Protections:	Short-circuit, overload, over temperature, over voltage, wrong connections
Isolation:	2KV AC (Opto-isolated)



INTEGRATED ANALOG INPUT

Type: Differential configurable analogue inputs, channel to channel isolated

Input ranges:

- Voltage mode: 0 to 10V, 0 to 5V, -5V to +5V, -10V to +10V
- Current mode: 0 to 20mA, -20mA to +20mA, 4mA to 20mA

Mode selection: By on-board jumpers for each channel (jumper set/on: current mode, remove jumper: voltage mode)

Input impedance:

- Voltage mode: More than 1MΩ
- Current mode: 125 Ohm ±0.1%

Effective resolution: 16 bit
 ADC resolution: 24 bit
 Update time: 30ms (for all channels)

Accuracy:

- At 25°C: ±0.1%
- Over temperature range: ±0.25%

Linearity: > ± 0.001%
 Temperature Stability: > ± 25ppm/°C (typical)

Isolation:

- Input to electronics: At least 350V
- Channel to channel: At least 350V

Common mode voltage: Max. ±80V DC
 CMRR: Min. 80dB
 Digital Low-pass filter: Yes (Configurable)

Power Frequency noise rejection:

- Default: 50Hz
- Option: 60Hz (set by manufacturer)

Absolute maximum ratings:

- Voltage: ±40V DC
- Current: ±40mA

POWER SUPPLY

Nominal input voltage:

- Type 05: 12-24VDC
- Type 10: 115-230VAC/DC
- Type 30: 24-48VDC

Absolute maximum input range:

- Type 05: 10 - 30V DC
- Type 10: 90-265VAC/DC
- Type 30: 20-60VDC

Input frequency:

- Types 05 and 30: DC
- Type 10: 40-70Hz

Power consumption:

- Type 05: 4W (Typ.), 10W (Max.)
- Type 10: 5W (Typ.), 15W (Max.)
- Type 30: 5W (Typ.), 14W (Max.)

Isolation (for all types): 3750 VDC

Indicators:

LED Indicators:

- CPU: On = CPU ok
- COM1: Indicating Rx/Tx activity on COM1.
- COM2: Indicating Rx/Tx activity on COM2.
- COM3: Indicating Rx/Tx activity on COM3.

LCD Display (and Keys):

The LCD Display has a backlight that shuts down after 1 minute of inactivity and allows both auto scroll and manual viewing modes. In auto scroll mode the I/O and RTU status values are displayed in turn for ~1 second eg. DI 0-7, DI 8-15, AI 0, AI 1...



Example Display



Display Controls

In Manual mode the user can scroll through the displays using the UP, DOWN, ENTER and ESCAPE buttons.



I/O Addressing:

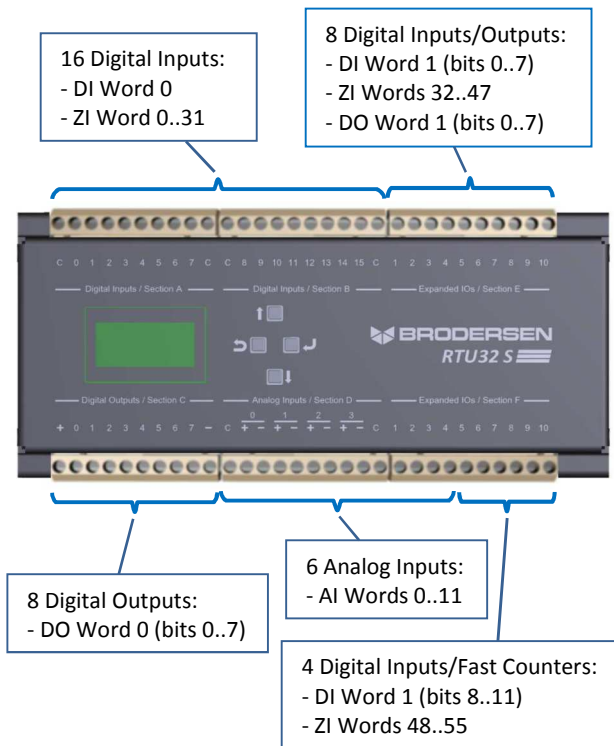

DI Words:

- DI Word 0: Digital Inputs 0..15
- DI Word 1 (bits 0..7): Digital Inputs 16..23
- DI Word 1 (bits 8..11): Digital Inputs 24..27

ZI Words:

- ZI Words 0..1: Counter Input 0 (32-bit)
- ZI Words 2..3: Counter Input 1 (32-bit)
- ...
- ZI Words 54..55: Counter Input 27 (32-bit)

DO Words:

- DO Word 0 (bits 0..7): Digital Outputs 0..7
- DO Word 0 (bits 8..15): Digital Outputs 8..15

AI Words:

- AI Word 0: Analog Input 0 Value (16-bit)
- AI Word 1: Analog Input 0 Status
- AI Word 2: Analog Input 1 Value (16-bit)
- AI Word 3: Analog Input 1 Status
- ...
- AI Word 10: Analog Input 5 Value (16-bit)
- AI Word 11: Analog Input 5 Status

Analog Input Status Word:

- 0: OK
- 1: Underflow
- 2: Overflow
- 3: Invalid data
- 4: Disabled
- 5..65535: Reserved

GENERAL

- Protection: IP20
- Mounting: DIN rail (EN50022) or Wall mounting (via optional mounting kit)
- Housing: Black corrosion protected aluminum housing
- Dimensions (WxHxD):
 - Basic version: 178x80x80mm
- Weight: 0.8kg (Approx.)

Standards and compatibility – environmental

Ambient temperature:

- Operation:
 - Standard: -20 - +60°C
 - Extended version: -40 - +70°C

- Storage: -40 - +85°C

EMC/LVD:

- IEC61000-3-2:2000
- IEC61000-3-3:1995+A1
- EN55022:1998 Class A
- EN55024:1998+A1+A2
- EN61000-6-2:2005 (with reference to EN61000-4-2:1995, EN61000-4-3:2002, EN61000-4-4:2004, EN61000-4-5:1995, EN61000-4-6:2007, EN61000-4-8:1993, EN61000-4-11:2004)
- IEC60950-1:2003 Safety requirements for electrical equipment for measurement and control

Climatic:

- Dry heat: IEC 60068-2-2, Test Bd, Temp. +55°C, Duration 8h
- Cold: IEC 60068-2-1, Test Ad, Temp. -10°C, Duration 8h
- Damp heat: IEC 60068-2-3, Test Ca, Temp. 40°C, RH 95%, Duration 8h

Mechanical:

- Vibration: IEC 60068-2-6, Test Fc (sinusoidal), Freq. 10-150Hz, Amp.4g, 5 sweeps in 3 orthogonal axes
- Shock: IEC 60068-2-27 (half sine), Acc. 15g, Pulse time 11 msec, 3 x 6 shocks



CIRCUIT CONFIGURATION

Digital Input:

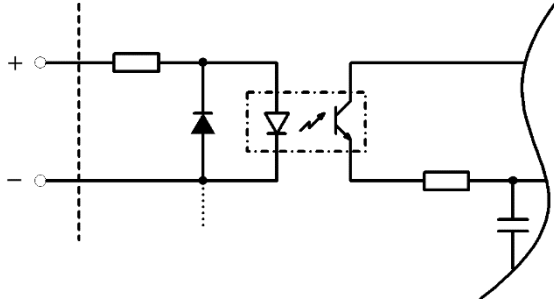

Digital Output (Smart high side switch):

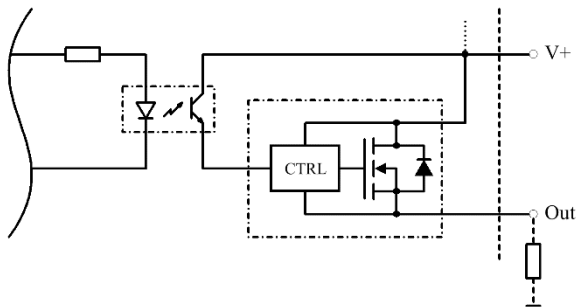

Analog Input:

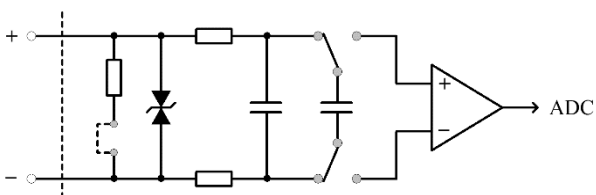

NOTE:
This data sheet is subject to change without notice!